

FOLD



User's Guide
Personal DVD player

Manual del Usuario
Tocadiscos DVD personal

Guide d'utilisation
Lecteur DVD personnel

DP3500-POW



CONTENTS

Contents	1
Important Safety Instructions	2
Precautions	4
Using the Stand	5
Power Sources	5
Location of Controls	7
About Discs	8
Important Note Regarding This Owner's Manual	9
Quick Setup Menu	10
•Player Menu	10
•Screen Display Aspect	10
Main Setup Menu	11
•Language	11
•Display	12
•Audio (DRC)	12
•Parental	13
Basic Operation	14
•Volume	14
•Menu Button	14
•Power Switch	14
•Headphone Jacks	14
DVD Basic Operation	15
•Playback of a DVD	15
•Skip	16
•Search	16
•Pause	16
•Slow Motion	16
MP3 Basic Operation	17
•Playback of an MP3 CD	17
•Search	17
•MP3 FAQs	17
CD Basic Operation	18
•Playback of a CD	18
•Search	18
•Skip	18
Picture CD Basic Operation	19
•Playback of a Picture CD	19
Troubleshooting Guide	20
Care and Maintenance	21
Specifications	22

IMPORTANT SAFETY INSTRUCTIONS

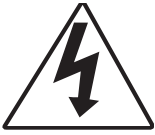

CAUTION

**RISK OF ELECTRIC SHOCK
DO NOT OPEN**



The lightning flash with arrowhead symbol within an equilateral triangle is intended to alert the user to the presence of uninsulated dangerous voltage within the product's enclosure that may be of sufficient magnitude to constitute a risk of electric shock to persons.



The exclamation point within an equilateral triangle is intended to alert the user to the presence of important operating and maintenance (servicing) instructions in the literature accompanying the appliance.

CAUTION: TO REDUCE THE RISK OF ELECTRIC SHOCK, DO NOT REMOVE COVER (OR BACK). NO USER-SERVICEABLE PARTS INSIDE. REFER SERVICING TO QUALIFIED SERVICE PERSONNEL.

CAUTION:

THIS DIGITAL VIDEO DISC PLAYER EMPLOYS A LASER SYSTEM.

TO ENSURE PROPER USE OF THIS PRODUCT, PLEASE READ THIS OWNER'S MANUAL CAREFULLY AND RETAIN FOR FUTURE REFERENCE. SHOULD THE UNIT REQUIRE MAINTENANCE, CONTACT AN AUTHORIZED SERVICE LOCATION-SEE SERVICE PROCEDURE.

USE OF CONTROLS, ADJUSTMENTS OR THE PERFORMANCE OF PROCEDURES OTHER THAN THOSE SPECIFIED HEREIN MAY RESULT IN HAZARDOUS RADIATION EXPOSURE.

TO PREVENT DIRECT EXPOSURE TO LASER BEAM, DO NOT TRY TO OPEN THE ENCLOSURE. VISIBLE LASER RADIATION MAY BE PRESENT WHEN THE ENCLOSURE IS OPENED. DO NOT STARE INTO BEAM.

WARNING:

TO REDUCE THE RISK OF FIRE OR ELECTRIC SHOCK, DO NOT EXPOSE THIS PRODUCT TO RAIN OR MOISTURE.

WARNING:

TO REDUCE THE RISK OF FIRE OR ELECTRIC SHOCK, AND ANNOYING INTERFERENCE, USE THE RECOMMENDED ACCESSORIES ONLY.

SURGE PROTECTORS:

It is recommended to use a surge protector for AC connection. Lightning and power surges ARE NOT covered under warranty for this product.

LASER WARNING:

This unit employs a Laser only qualified service personal should attempt to service this device due to possible eye injury

FCC NOTICE:

This equipment has been tested and found to comply with the limits for a Class B digital device, pursuant to part 15 of the FCC Rules. These limits are designed to provide reasonable protection against harmful interference in a residential installation. This equipment generates, uses and can radiate radio frequency energy and, if not installed and used in accordance with the instructions, may cause harmful interference to radio communications.

However, there is no guarantee that interference will not occur in a particular installation. If this equipment does cause harmful interference to radio or television reception, which can be determined by turning the equipment off and on, the user is encouraged to try to correct the interference by one or more of the following measures:

- Reorient or relocate the receiving antenna.
- Increase the separation between the equipment and receiver.
- Connect the equipment into an outlet on a circuit different from that to which the receiver is connected.
- Consult the dealer or an experienced radio/TV technician for help.

Modification not authorized by the manufacture may void user authority to operated this device.

FCC CAUTION:

To assure continued compliance, follow the attached installation instructions and use only shielded cables when connecting to other devices. Also, any changes or modifications not expressly approved by the party responsible for compliance could void the user's authority to operate the equipment.

ATTENTION:

POUR ÉVITER LES CHOC ÉLECTRIQUES, INTRODUIRE LA LAME LA PLUS LARGE DE LA FICHE DANS LA BORNE CORRESPONDANTE DE LA PRISES ET POUSSER JUSQU'AU FOND.

IMPORTANT:

PLEASE KEEP ALL PACKAGING MATERIAL FOR AT LEAST 90 DAYS IN CASE YOU NEED TO RETURN THIS PRODUCT TO YOUR PLACE OF PURCHASE.

IMPORTANT SAFETY INSTRUCTIONS (CONTINUED)

Dear Customer:

Selecting fine audio equipment such as the unit you've just purchased is only the start of your musical enjoyment. Now it's time to consider how you can maximize the fun and excitement your equipment offers. This manufacturer and the Electronic Industries Association's Consumer Electronics Group want you to get the most out of your equipment by playing it at a safe level. One that lets the sound come through loud and clear without annoying blaring or distortion and, most importantly, without affecting your sensitive hearing.

Sound can be deceiving. Over time your hearing "comfort level" adapts to higher volumes of sound. So what sounds "normal" can actually be loud and harmful to your hearing. Guard against this by setting your equipment at a safe level BEFORE your hearing adapts.

To establish a safe level:

- Start your volume control at a low setting.
- Slowly increase the sound until you can hear it comfortably and clearly, and without distortion.

Once you have established a comfortable sound level:

- Set the dial and leave it there.

Taking a minute to do this now will help to prevent hearing damage or loss in the future. After all, we want you listening for a lifetime.

We Want You Listening For A Lifetime

Used wisely, your new sound equipment will provide a lifetime of fun and enjoyment. Since hearing damage from loud noise is often undetectable until it is too late, this manufacturer and the Electronic Industries Association's Consumer Electronics Group recommend you avoid prolonged exposure to excessive noise. This list of sound levels is included for your protection.

Decibel

<u>Level</u>	<u>Example</u>
30	Quiet library, soft whispers
40	Living room, refrigerator, bedroom away from traffic
50	Light traffic, normal conversation, quiet office
60	Air conditioner at 20 feet, sewing machine
70	Vacuum cleaner, hair dryer, noisy restaurant
80	Average city traffic, garbage disposals, alarm clock at two feet

THE FOLLOWING NOISES CAN BE DANGEROUS UNDER CONSTANT EXPOSURE:

90	Subway, motorcycle, truck traffic, lawn mower
100	Garbage truck, chain saw, pneumatic drill
120	Rock band concert in front of speakers, thunderclap
140	Gunshot blast, jet engine
180	Rocket launching pad

Information courtesy of the Deafness Research Foundation.



PRECAUTIONS

NOTES ON HANDLING:

- When shipping the DVD player, always use the original shipping carton and packing materials. For maximum protection, repack the unit as it was originally packed at the factory.
- Do not use volatile liquids, such as insect spray, near the DVD player. Do not leave rubber or plastic products in contact with the DVD player for a long time. They will leave marks on the finish.
- The top and rear panels of the DVD player may become warm after a long period of use. This is normal and not a malfunction.
- When the DVD player is not in use, be sure to remove the disc and turn off the power.
- If you do not use the DVD player for a long period, the unit may not function properly in the future. Turn on and use the DVD player occasionally.

NOTES ON LOCATING THE DVD PLAYER:

- When you place this DVD player near a TV, radio or VCR, the playback picture may become poor and the sound may be distorted. In this case, move the DVD player away from the TV, radio or VCR.

NOTES ON CLEANING:

Use a soft, dry cloth for cleaning.

- For stubborn dirt, soak the cloth in a weak detergent solution, wring well and wipe. Use a dry cloth to wipe it dry. Do not use any type of solvent, such as thinner or benzene, as they may damage the surface of the DVD player.
- If you use a chemical-saturated cloth to clean the unit, follow that product's instructions.

Warning: Cleaning and adjustment of lenses and/or other components of playback mechanism should be performed by a qualified service technician.

TO OBTAIN A CLEAR PICTURE:

The DVD player is a high technology, precision device. If the optical pick-up lens and disc drive parts are dirty or worn down, the picture quality becomes poor. To obtain a clear picture, we recommend regular inspection and maintenance (cleaning or parts replacement) every 1,000 hours of use depending on the operating environment. For details, contact your nearest dealer.

NOTES ON MOISTURE CONDENSATION:

Moisture condensation damages the DVD player. Please read the following carefully.

- Moisture condensation occurs, for example, when you pour a cold drink into a glass on a warm day. Drops of water form on the outside of the glass. In the same way, moisture may condense on the optical pick-up lens inside this unit, one of the most crucial internal parts of the DVD player.

Moisture condensation occurs during the following cases:

- When you bring the DVD player directly from a cold place to a warm place.
- When you use the DVD player in a room where you just turned on the heater, or a place where the cold wind from the air conditioner directly hits the unit.
- In summer, when you use the DVD player in a hot and humid place just after you moved the unit from an air conditioned room.
- When you use the DVD player in a humid place.

Do not use the DVD player when moisture condensation may occur.

- If you use the DVD player in such a situation, it may damage discs and internal parts. Remove the disc, insert the small end of the AC adapter into the DC IN jack on the side of the unit and insert the other end into a conveniently located AC outlet having 120 AC, 60 Hz, turn on the DVD player and leave it "ON" for two or three hours. After two or three hours, the DVD player will have warmed up and evaporated any moisture. Keep the DVD player connected to the wall outlet and moisture condensation will seldom occur.

CAUTION:

To reduce the risk of injury, only charge with supplied rechargeable batteries; other types of batteries may burst causing personal injury or damage.

USING THE STAND

1

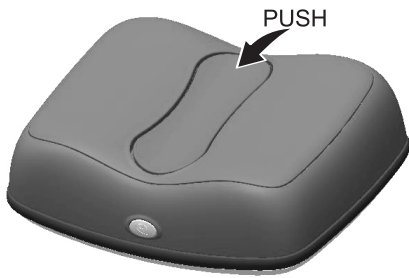

Push in on the top of the Stand to release the Stand.

2



Pull the Stand out.

3



Carefully stand the unit.

POWER SOURCES

AC CONNECTION

Insert the small end of the AC adapter into the DC IN jack on the side of the unit. Insert the other end (with the 2 blades) into a conveniently located AC outlet having 120V AC, 60Hz.

AC Adapter Specification : 9V DC, $\ominus\oplus$

NOTE:

- Use the enclosed AC adapter for this product only.
- To disconnect the AC adapter, remove it from the DC IN jack on the side of the unit as well as from the AC outlet.

CHARGING THE battery packss

Insert the small end of the AC adapter into the DC IN jack on the side of the unit. Insert the other end (with the 2 blades) into a conveniently located AC outlet having 120V AC, 60Hz and **MAKE SURE THE POWER ON/OFF SWITCH IS IN THE OFF POSITION**. The CHARGE indicator will light red as the battery is charging and the FULL indicator will light green when charging has completed. Disconnect the AC adapter plugs when the charging has finished.

NOTE: Fully charge the battery packs (5 hours) before using it for the first time.

BATTERY NOTES:

- Make sure the battery packs is charged at least once a year.
- When fully charged, the unit can be used for approximately 2.5 hours.
- When the unit is in the Stop mode or there is no disc inserted and no button is pressed for around three minutes, the screen saver will automatically appear in the display. If it is no button is pressed for 10 minutes, the unit will enter the Standby mode (the display will turn off) and the screen saver will disappear. Press any button to resume and to turn on again.

BATTERY LOW INDICATOR

When the rechargeable battery packs becomes weak, the LOW BATTERY indicator will light and you will have 15 more minutes of playing time. Charge the battery fully (3 to 3.5 hours) in this situation or use AC power.

POWER SOURCES (CONTINUED)

REPLACING THE RECHARGEABLE BATTERY PACKS

It is very rare that the rechargeable battery packs will require replacing. If you charge up the rechargeable battery for 3-3.5 hours but the battery only can playback/operate for a short period of time, then the battery packs need to be replaced. Contact customer services (contact information is on rear cover page) to purchase a new battery and follow the steps to replace the rechargeable battery packs.

1

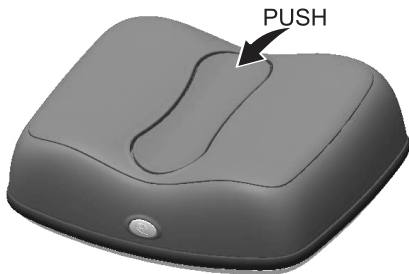

Push in on the top of the Stand to release the Stand.

2



Pull the Stand out.

3



Remove the screw under the Stand using a Philips screwdriver.

4

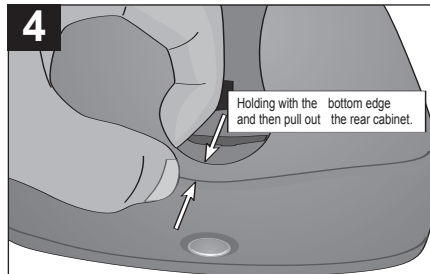

Hold the bottom edge and pull out the rear cabinet.

5

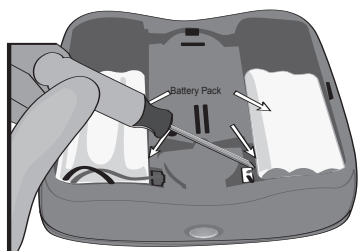

Disconnect the connectors, then use a screwdriver to remove the battery packs.

6

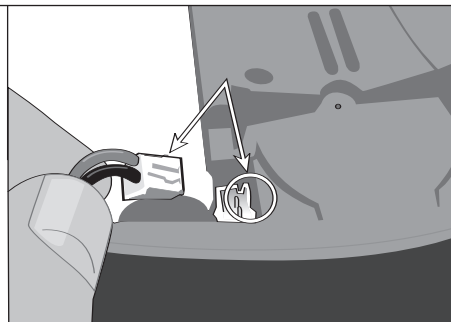

Insert the new rechargeable batteries to the unit. Insert the connector into the jack, making sure to align it properly as shown.

7

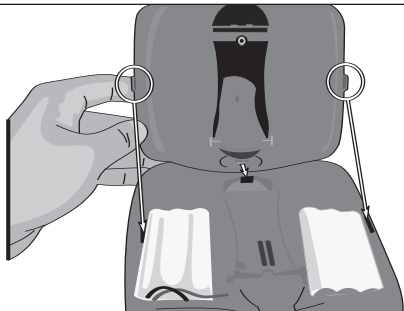

Replace the rear cabinet, making sure the three tabs are aligned to the corresponding slots on the main unit.

8



Replace the screw.

IMPORTANT: Only replace battery packs with one purchased from Memorex. Other battery packs may cause unit failure, shock, etc.

LOCATION OF CONTROLS

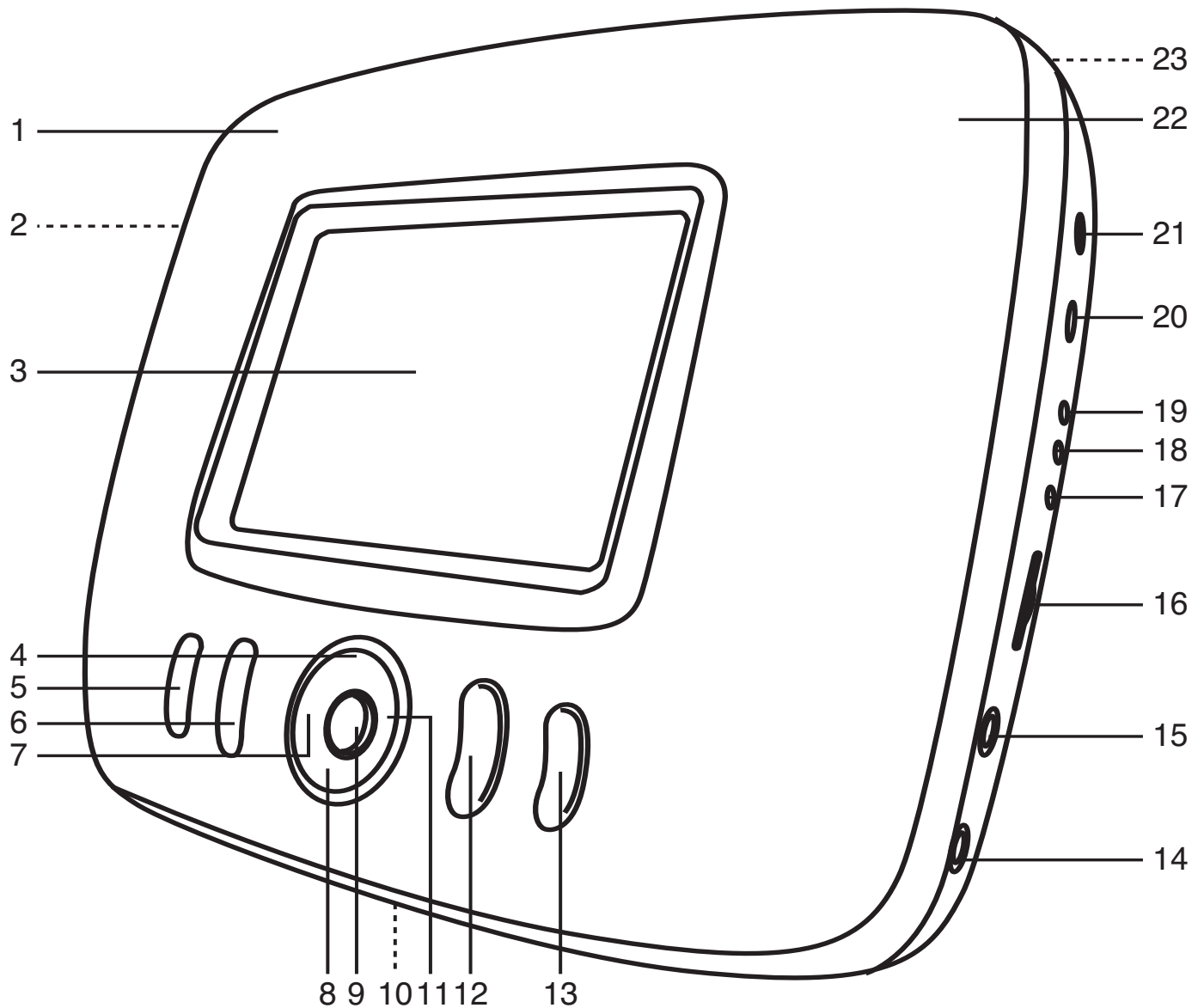

- | | |
|--|---|
| <ul style="list-style-type: none"> 1. Speaker 2. Stand (Rear of Unit) 3. Display 4. PAUSE ■■/Navigation Up Button* 5. Menu Button 6. Setup Button 7. Skip ◀◀/Navigation Left Button* 8. STOP (■)/Navigation Down Button* 9. ENTER/PLAY ▶ Button* 10. Door OPEN Button (Bottom of Unit) 11. Skip ▶▶/Navigation Right Button* 12. SEARCH ◀◀ Button 13. SEARCH ▶▶ Button | <ul style="list-style-type: none"> 14. Headphone 1 Jack 15. Headphone 2 Jack 16. VOLUME Control 17. Low Battery Indicator 18. Charging Indicator 19. Full Indicator 20. DC IN 9V Jack ⓂⓂⓂ 21. Power On/Off Switch 22. Speaker 23. Rechargeable Battery Compartment (Rear of Unit) |
|--|---|

* See bottom of page 9.

ABOUT DISCS

The region number for this DVD Player is:
See the following page for information regarding region numbers.



PLAYABLE DISCS:

The following discs can be played back on this DVD player:



MP3

When playing an MP3, the selected file will appear in the display and will list the folders/tracks.

MP3 is the abbreviation of "MPEG1 Audio Layer 3". MPEG Audio is a format that compresses the audio portion only.

IMPORTANT NOTES:

Due to many variables, including recording condition, type of disc, writing software, etc., this unit does not guarantee playback of all MP3 discs.

DISC TYPES:

DVD

Data on most DVDs is divided into sections called "titles" and then into subsections called "chapters", each of which is given a title or chapter number. Some features of this DVD player will not operate with some DVD discs as they are preset. If a function you selected does not run as desired, refer to the manual accompanying the DVD disc.

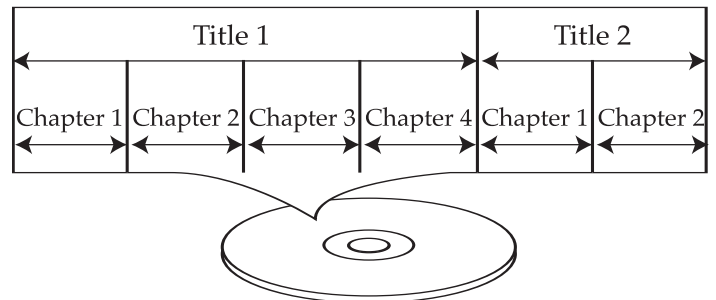

AUDIO CD

Data on an audio CD is divided into sections called "tracks", each of which is given a track number.

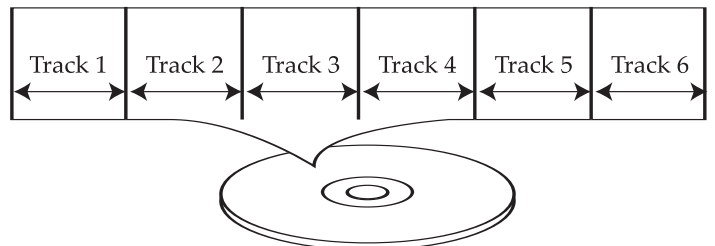

IMPORTANT:

It is important that you read the manual that accompanies the DVD disc, as there are features that are on the DVD player that cannot be used with certain DVDs. There are also extra features on the DVD disc that are different for each DVD disc, so they are not explained in this owner's manual.

ABOUT DISCS (CONTINUED)



Notes on Copyright:

It is forbidden by law to copy, broadcast, show, broadcast on cable, play in public and rent copyrighted material without permission. DVD video discs are copy protected, and any recordings made from these discs will be distorted. This product incorporates copyright protection technology that is protected by method claims of certain U.S. patents and other intellectual property rights owned by Macrovision Corporation and other rights owners. Use of this copyright protection technology must be authorized by Macrovision Corporation, and is intended for home and other limited viewing uses only, unless otherwise authorized by Macrovision Corporation. Reverse engineering or disassembly is prohibited.

Region Management Information:

This DVD Player is designed and manufactured to respond to the Region Management Information that is recorded on a DVD disc. If the Region number described on the DVD disc does not correspond to the Region number of this DVD player, this DVD player cannot play that disc. You may not be able to play back some DVD video discs on this player if they were purchased from outside your geographic area or made for business purposes. When you try to play back an unauthorized disc, "Wrong Region" appears on the Display screen.

IMPORTANT NOTE REGARDING THIS OWNER'S MANUAL

There are five buttons that perform dual functions. In this manual, they will be labeled as the function they are performing. For example, when the SKIP /Navigation Left button is mentioned in the manual to describe skipping a track, it will be called SKIP  button. If it is mentioned to describe navigating through a menu, then it will be called Navigation Left button.

Below are the buttons with dual labels:

PAUSE /Navigation Up button

Skip /Navigation Left button

STOP /Navigation Down button

ENTER/PLAY  button

Skip /Navigation Right button

QUICK SETUP MENU

The Quick Setup menu lets you customize the DVD player by allowing you to select the on-screen language preference and the Screen Display aspect. Use the following instructions to navigate and change the options:

1. While in the Stop mode, press the SETUP button to enter the Setup Menu.
2. Select the Quick Setup icon at the top of the display using the Navigation Left or Right button, then press the ENTER button.
3. Select one of the setup options using the Navigation Up or Down button, then press the ENTER button.
4. See steps below to change the selected setting.

PLAYER MENU

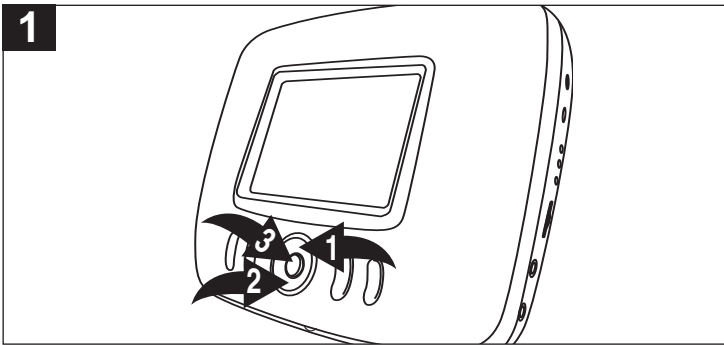

Select the language the PLAYER MENU will be in (ENGLISH, FRENCH, SPANISH) using the Navigation Up ❶ or Down ❷ button. When the desired language is selected, press the ENTER button ❸.

SCREEN DISPLAY ASPECT

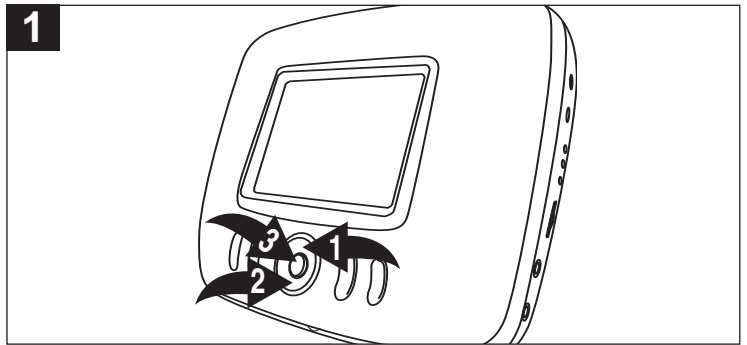

Select the desired option using the Navigation Up ❶ or Down ❷ button. When the desired setting is selected, press the ENTER button ❸.

4:3 PS (Pan Scan): When selected, video material formatted in the Pan Scan style is played back in that style (the left and right edges are cut off).

4:3 LB (Letterbox): When selected, wide-screen images are shown on the screen with a black band at the top or bottom.

16:9 Wide: Select for a 16:9 ratio.

MAIN SETUP MENU

The Main Setup menu lets you customize the DVD player by allowing you to select various language, audio, parental preferences and more. Use the following instructions to navigate and change the options:

1. While in the Stop mode, press the SETUP button to enter the Setup Menu.
2. Select the Setup icon at the top of the display using the Navigation Left or Right button, then press the ENTER button.
3. Select the desired icon (Language, Display, Audio or Parental) at the top of the display using the Navigation Left or Right button, then press the ENTER button.
4. Select one of the options using the Navigation Up or Down button, then press the ENTER button.
5. See steps below and on the following pages to change the selected setting.

LANGUAGE

AUDIO LANGUAGE

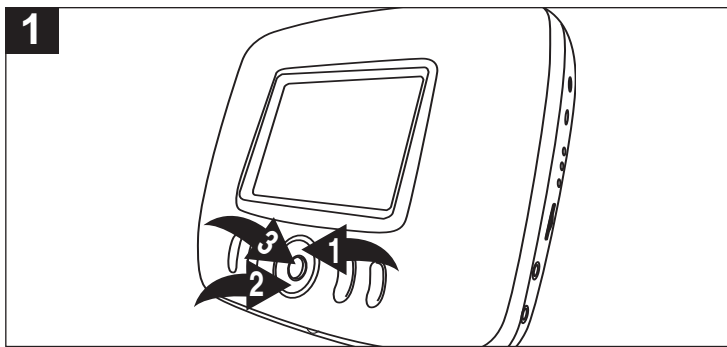

Select the language the DVD will be played back in (Original, English, French, Spanish, German, Italian, Swedish, Dutch, Japanese, Chinese, Korean, Danish, Finnish, Norwegian, Icelandic, Hungarian, Romanian, Turkish, Greek, Russian, Irish, Portuguese or other) using the Navigation Up ❶ or Down ❷ button. When the desired language is selected, press the ENTER button ❸. The DVD must be recorded in the selected language, otherwise the default language of the DVD will be played.

SUBTITLE

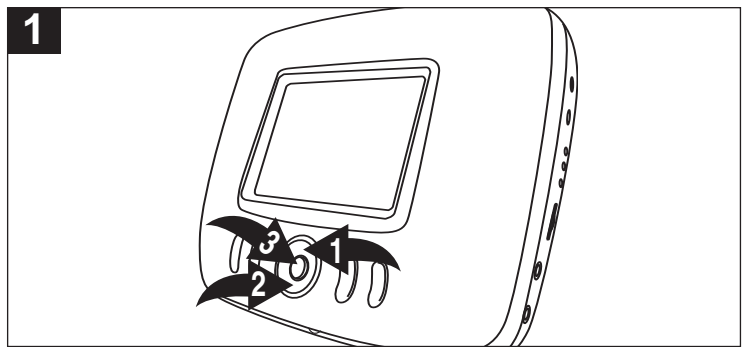

Select the language the subtitle (OSD) will be in (Off, English, French, Spanish, German, Italian, Swedish, Dutch, Japanese, Chinese, Korean, Danish, Finnish, Norwegian, Icelandic, Hungarian, Romanian, Turkish, Greek, Russian, Irish, Portuguese or other) using the Navigation Up ❶ or Down ❷ button. When the desired language is selected, press the ENTER button ❸. The DVD must be recorded in the selected language, otherwise the default language of the DVD will be shown.

DISC MENU

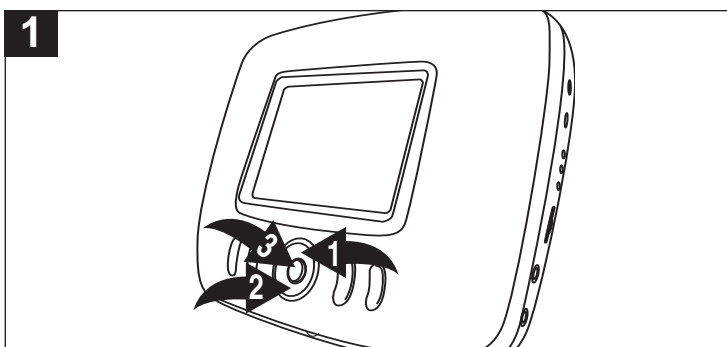

Select the language the Disc Menu will be in (English, French, Spanish, German, Italian, Swedish, Dutch, Japanese, Chinese, Korean, Danish, Finnish, Norwegian, Icelandic, Hungarian, Rumanian, Turkish, Greek, Russian, Irish, Portuguese or other) using the Navigation Up ❶ or Down ❷ button. When the desired language is selected, press the ENTER button ❸. The DVD's disc menu must be made in the selected language, otherwise the default language of the DVD will be shown.

PLAYER MENU

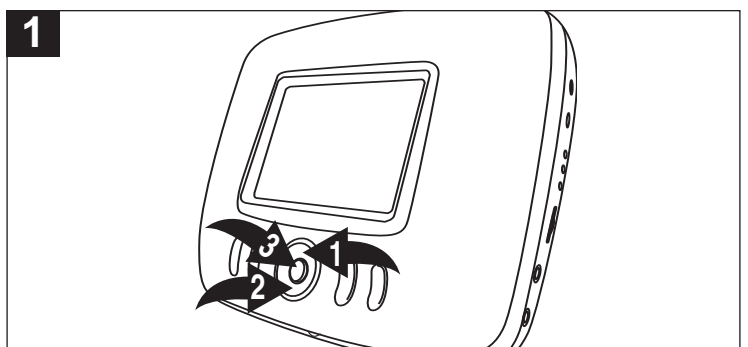

Select the language the player's menu will be in (English, French or Spanish) using the Navigation Up ❶ or Down ❷ button. When the desired language is selected, press the ENTER button ❸.

MAIN SETUP MENU (CONTINUED)

DISPLAY

SCREEN DISPLAY ASPECT

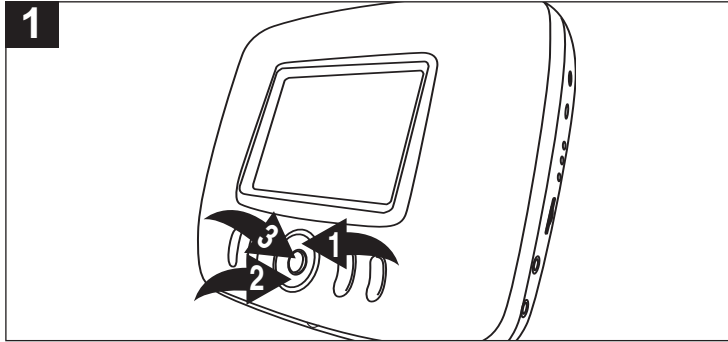

Select the desired option using the Navigation Up **1** or Down **2** button. When the desired setting is selected, press the ENTER button **3**.

4:3 PS (Pan Scan): When selected, video material formatted in the Pan Scan style is played back in that style (the left and right edges are cut off).

4:3 LB (Letterbox): When selected, wide-screen images are shown on the screen with a black band at the top or bottom.

16:9 Wide: Select for a 16:9 ratio.

BRIGHTNESS

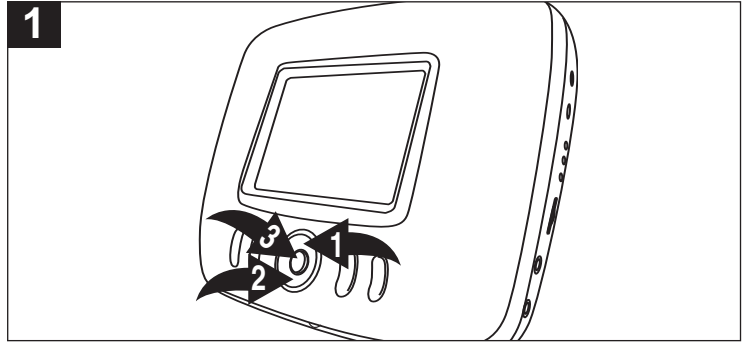

Select the brightness setting using the Navigation Up **1** or Down **2** button. When the desired setting is selected, press the ENTER button **3**.

CONTRAST

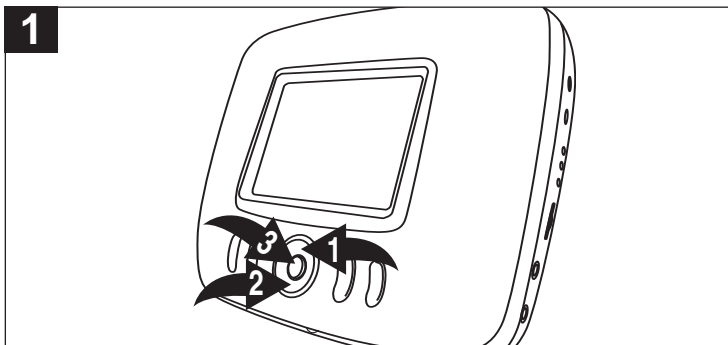

Select the contrast setting using the Navigation Up **1** or Down **2** button. When the desired setting is selected, press the ENTER button **3**.

COLOR

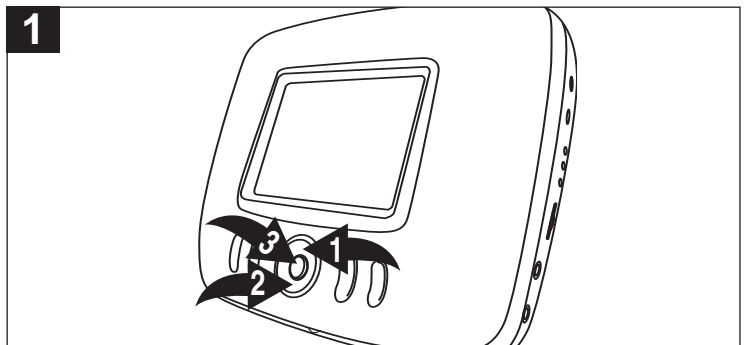

Select the color setting using the Navigation Up **1** or Down **2** button. When the desired setting is selected, press the ENTER button **3**.

AUDIO (DRC)

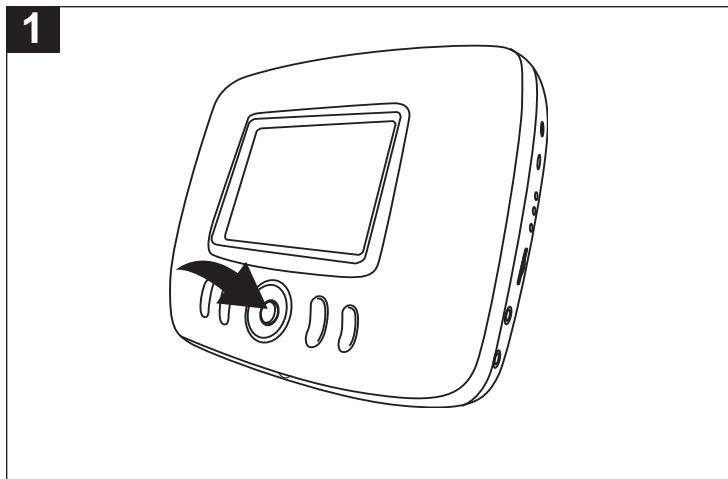

Turn DRC (Dynamic Range Compression) On or Off using the ENTER button. Turning this option on will compress the dynamic range of the DVD's audio track.

MAIN SETUP MENU (CONTINUED)

PARENTAL

The Parental option enables parents to prevent their children from watching inappropriate material on a DVD. It reads the ratings for programming, then denies access to programming if the program's rating meets the limitations you select. In this case, the user will have to enter a password.

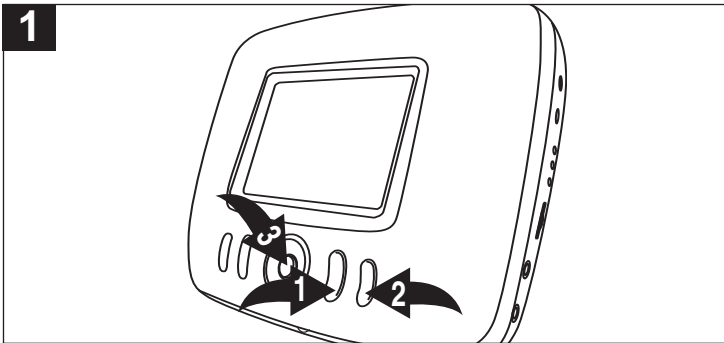

After Parental is selected, the Password screen will appear. Enter the first digit of the password using the SEARCH ◀◀ ① or ▶▶ ② button, then press the ENTER button ③. Repeat to enter all four digits.
NOTE: The default password is "1234", so use this password when setting for the first time.

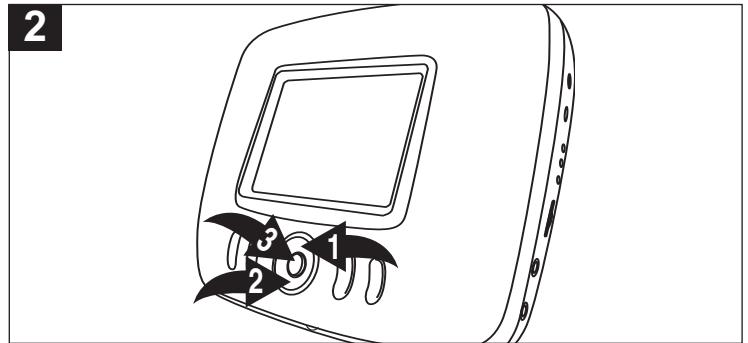

Select Parental Level using the Navigation Up ① or Down ② button, then press the ENTER button ③.

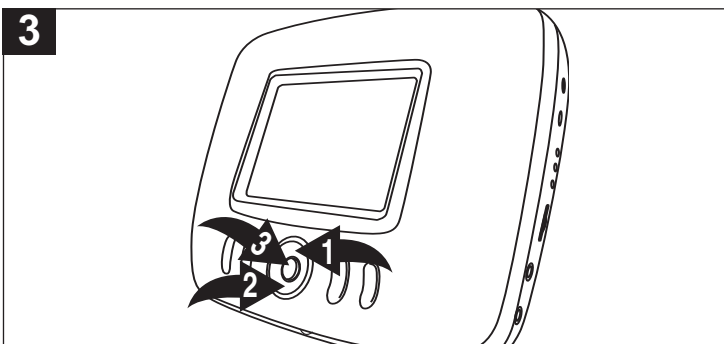

Select the desired level using the Navigation Up ① or Down ② button, then press the ENTER button ③.

1 (KIDSAFE): Kidsafe.	6 (R): Under 17 years old, Parental Guidance suggested.
2 (G): All ages.	7 (NC17): 17 years old and above.
3 (PG): Parental Guidance.	8 (ADULT): Adult only.
4 (PG13): Parental Guidance less than 13 years old.	
5 (PGR): Under 17 years old, Parental Guidance	

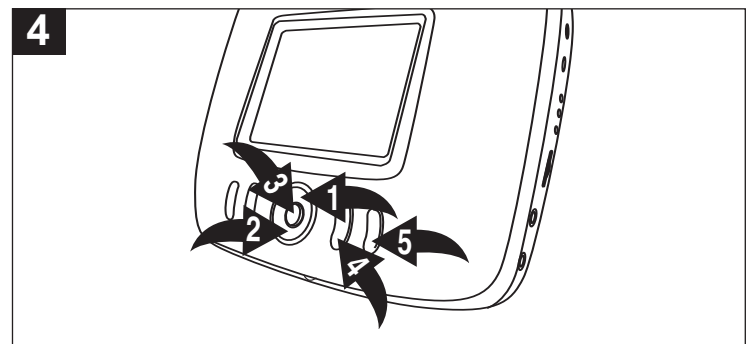

TO CHANGE THE PASSWORD:
 Select Change using the Navigation Up ① or Down ② button, then press the ENTER button ③. Enter the first digit of the password using the SEARCH ◀◀ ④ or ▶▶ ⑤ button, then press the ENTER button ③. Repeat to enter all four digits. Then write the password down and press the ENTER button ③ again to confirm new password.

BASIC OPERATION (GENERAL)

VOLUME

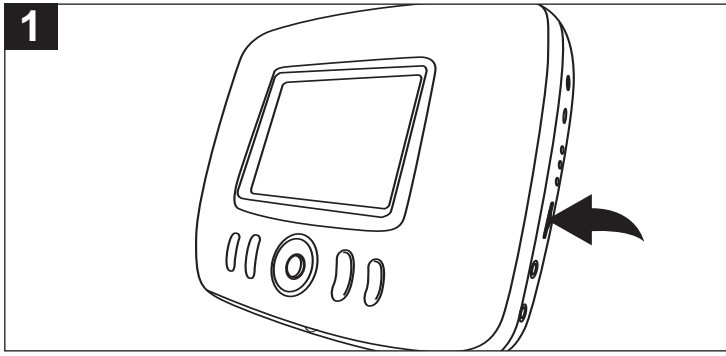

1 Adjust the volume using the VOLUME control.

MENU BUTTON

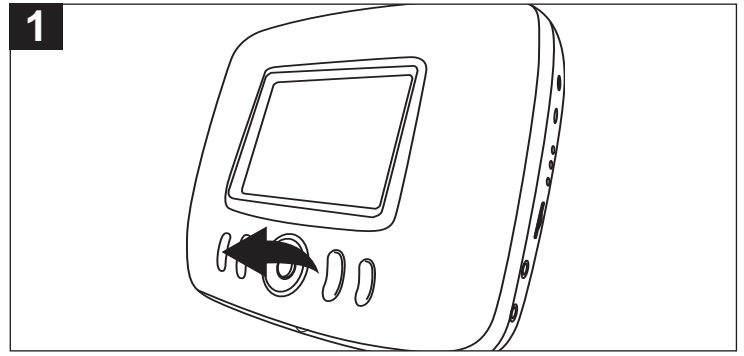

1 When playing a DVD, press the MENU button to return to the DVD's main menu.

POWER SWITCH

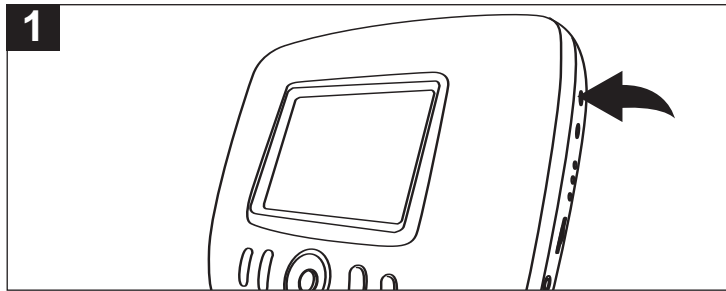

1 Slide to the ON position to turn the unit on. Slide to the OFF position to turn the unit off.

HEADPHONE JACKS

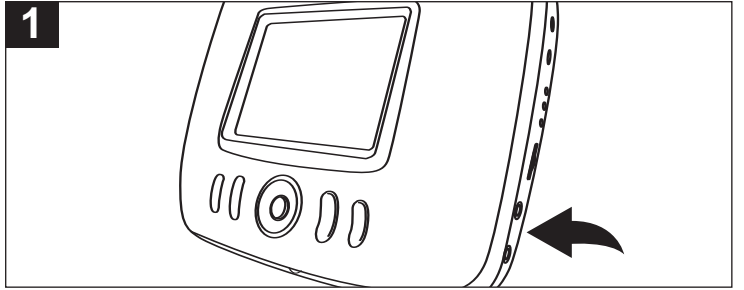

1 For private listening, plug one or two headphones into these jacks. The speakers will be disconnected when a plug is inserted into one of these jacks.

STANDBY:

When the unit has been stopped for approximately three minutes, the screen saver will appear in the display. If no button is pressed for approximately 10 minutes while in the Stop mode, the unit will enter the Standby mode to save battery power. Press any button to exit the Standby mode and turn the unit on again.

DVD BASIC OPERATION

PLAYBACK OF A DVD

1

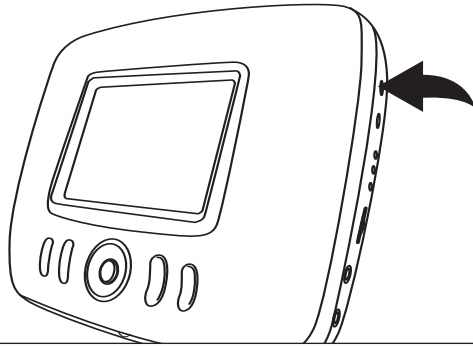

Slide the POWER switch to the ON position.

2

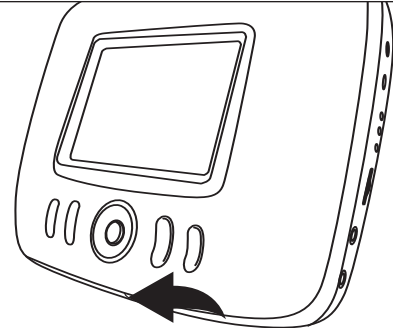

Press the Door OPEN button to open the disc tray. Insert a disc with the label side facing up onto the disc tray.

3

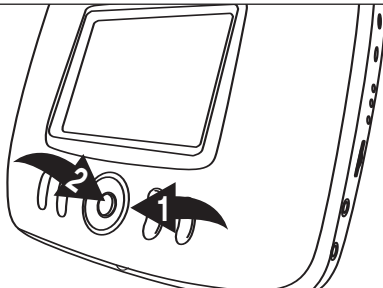

Close the disc tray. After loading, the menu screen of the DVD should appear. Use the Navigation buttons ❶ to select the desired option and press the ENTER button ❷ to select it.

4

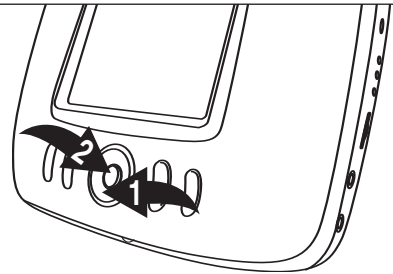

To stop playback, press the Stop (■) button ❶. Because the unit will remember where you stopped, simply press the Play (▶) button ❷ to resume playback where you left off (resuming playback).

If the Stop (■) button ❶ is pressed twice, the unit will stop completely.

NOTES:

- If a MENU appears on the display screen, press the Navigation buttons to select the desired option/item, then press the ENTER button. Please make sure to refer to the disc's jacket or case for additional information.
- Resuming playback may not work on all discs.

IMPORTANT NOTES:

- Mickey's hand will appear at the top right of the display screen during operation if you try to access a function that is not available on the disc.
- Some discs may take a few seconds to load.
- Always hold the disc without touching either of its surfaces. When inserting a disc, position it with the printed title side facing up, align it with the guides and place it in its proper position.
- It is important that you read the manual that accompanies the DVD disc as there are features that are on this DVD player that cannot be used with certain DVDs. There are also extra features that are different for each DVD disc, so they are not explained in this owner's manual.
- If there is no picture on the display screen, but the POWER switch is in the ON position, the unit may be in the Standby mode. See Standby function's information on the bottom of the previous page.

DVD BASIC OPERATION (CONTINUED)

SKIP

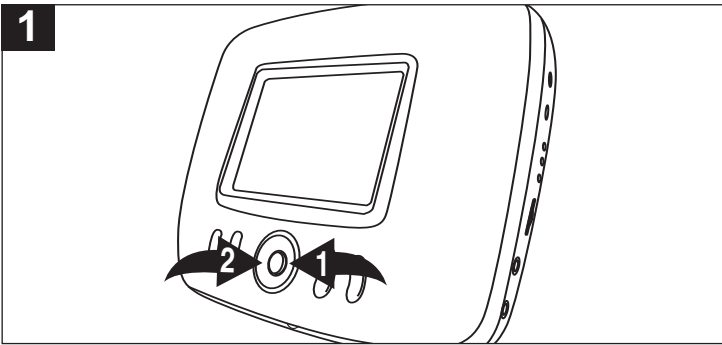

During playback, press the Skip (▶▶) button ❶ to advance the DVD to the beginning of the next chapter.

During playback, press the Skip (◀◀) button ❷ to move the DVD to the beginning of the previous chapters.

SEARCH

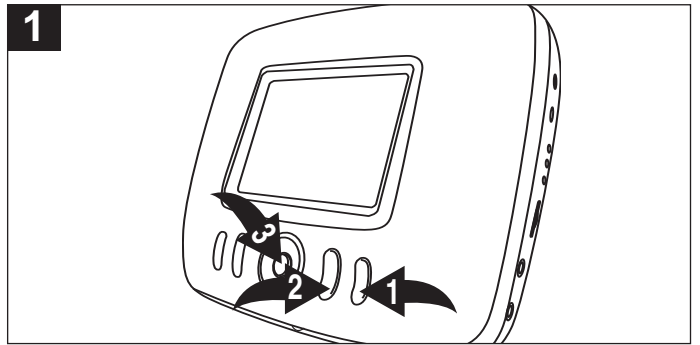

During playback, press either the Search ▶▶ button ❶ or Search ◀◀ button ❷ to move the DVD forward or backward at double (x2) speed to locate a specific section. Repeatedly press these buttons and the speed will increase to x4, x8, x16 (the sound will be muted) and resume normal playback.

The DVD will move forward or backward at high speed until the Play (▶) button ❸ is pressed; normal playback will resume at that point.

PAUSE

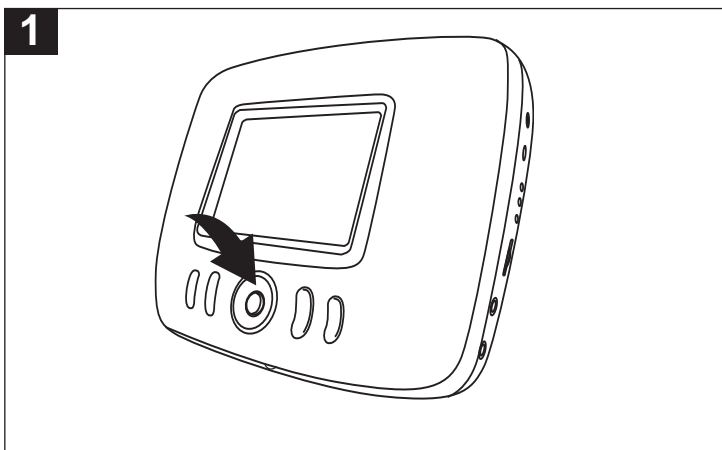

Press the Pause (||) button once to pause the picture.

Press the Pause (||) button again to resume normal playback.

SLOW MOTION

Use this feature to move the DVD in slow motion.

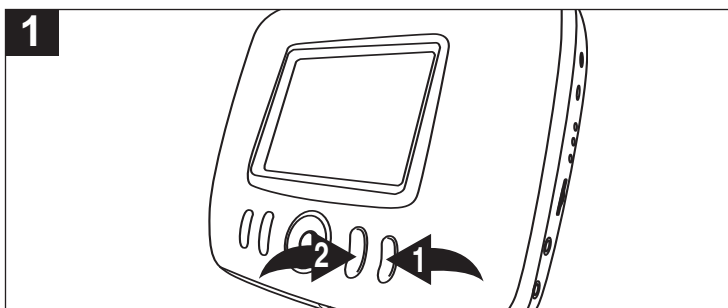

While the DVD is paused, press either the Search ▶▶ button ❶ or Search ◀◀ button ❷ to move the DVD forward or backward in slow motion speed of 1/2, 1/4, 1/8 and resume normal playback.

MP3 BASIC OPERATION

PLAYBACK OF AN MP3 CD

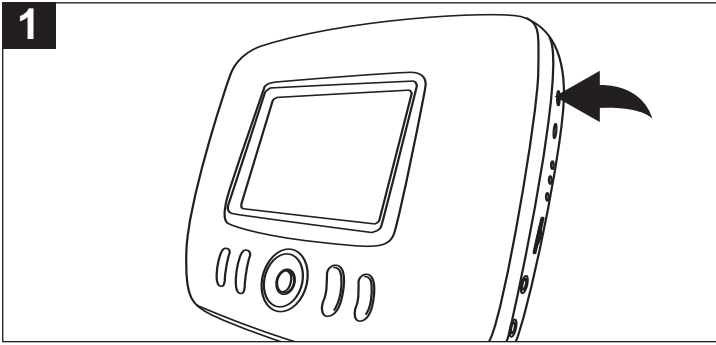

Slide the POWER switch to the ON position.

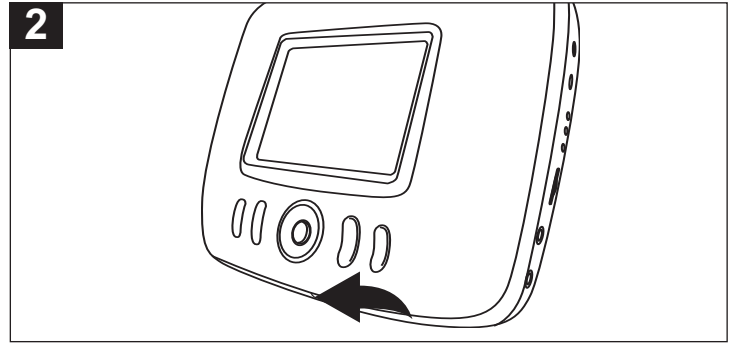

Press the Door OPEN button to open the disc tray. Insert a disc with the label side facing up on the disc tray.

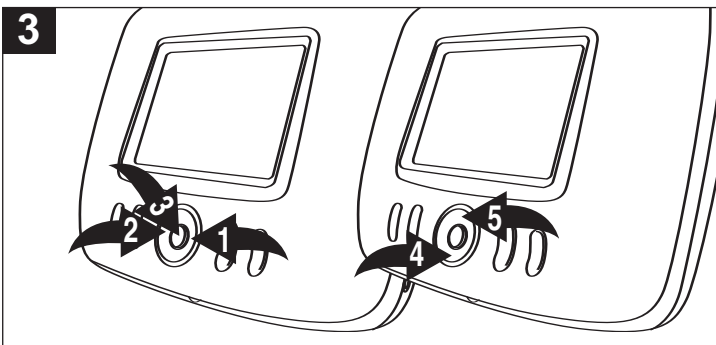

Close the disc tray. After loading, the FOLDER/TRACK menu will appear on the TV screen. Press the Skip \lll /Navigation left button ① or Skip \ggg /Navigation right button ② to select the desired folder/file, then press the ENTER button ③ to confirm; playback will begin if you selected a file. If you selected a Folder, then select a file using the Skip \lll /Navigation left button ① or Skip \ggg /Navigation right button ②, then press the ENTER button ③ to begin playback of the selected file. To return to the previous folder's menu, use the Skip \lll /Navigation left button ① or Skip \ggg /Navigation right button ② to select ".." then press the ENTER button to return to the previous folder's menu. Press the Stop (■) button ④ to Stop the playback. Press the Pause (⏸) button ⑤ once to pause the playback and press again to resume playback.

SEARCH

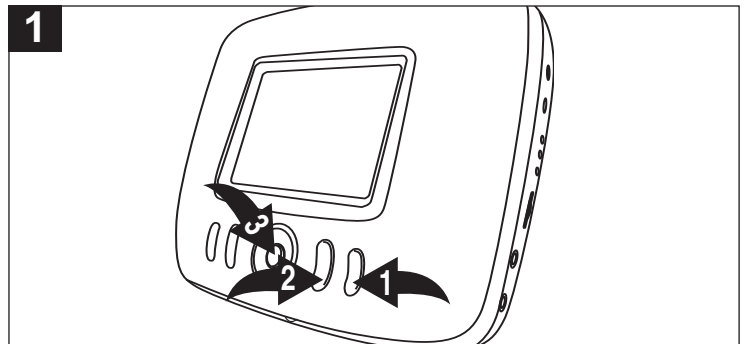

During playback, press either the Search \ggg button ① or Search \lll button ② to move the CD forward or backward at double (x2) speed to locate a specific section. Repeatedly press these buttons and the speed will increase to x4, x8, x16 and resume normal playback. The CD will move forward or backward at high speed until the Play (\blacktriangleright) button ⑥ is pressed; normal playback will resume at that point.

MP3 FAQs (Frequently Asked Questions) Please read before playing an MP3 CD.

What is an MP3 file?

An MP3 file is a computer format that makes a usually large music file into a smaller one which is more convenient to download and share.

Can I record my own MP3 CDs?

Yes, but you need a CD recorder, which is available from your local computer store.

Where can I find MP3 files?

MP3 files are available on the Internet.

Can this unit read regular music CDs?

Yes, it can. However, you cannot mix MP3s and WAV files on the same CD. If you do this, the CD Player will play only the MP3 files.

Can I use the MP3 extension for non-audio data files?

No, this may result in serious malfunction and harmful noise interference.

Can I mix MP3 files with other file types on the CDR?

Yes, but your CD player will ignore those files and read only the MP3 files on the CDR.

Does this unit support subdirectories (subfolders)?

Yes, it can read MP3 files from subfolders.

CD BASIC OPERATION

PLAYBACK OF A CD

1

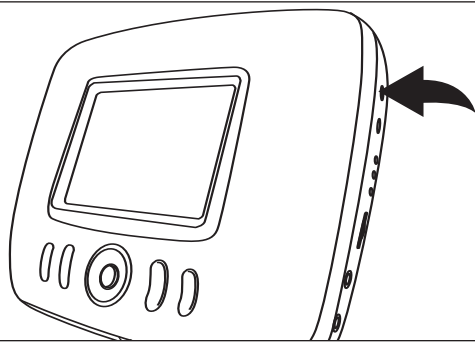

Slide the POWER switch to the ON position.

2

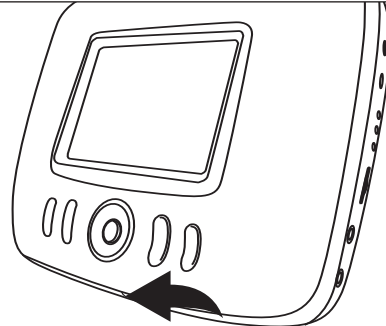

Press the Door OPEN button to open the disc tray. Insert a disc with the label side facing up on the disc tray.

3

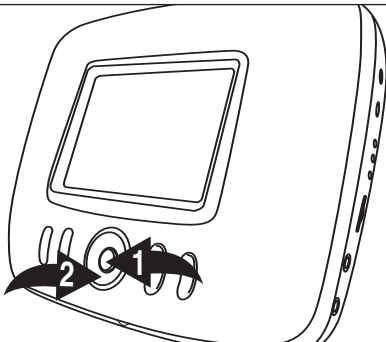

Close the disc tray, the CD will automatically start playing. The CD track number will appear in the screen for several second then disappear from the screen. After one minute, the screen saver will appear, then after two more minutes, then the screen will go blank (turn off) to save power. Press any button on the front panel to turn the screen on again. To stop the playback, press the Stop (■) button ❶. Because of the unit will remember where you stopped, simply press the Play (▶) button ❷ to resume playback where you left off (resuming playback). If the Stop (■) button ❶ is pressed twice, the unit will stop completely.

SEARCH

1

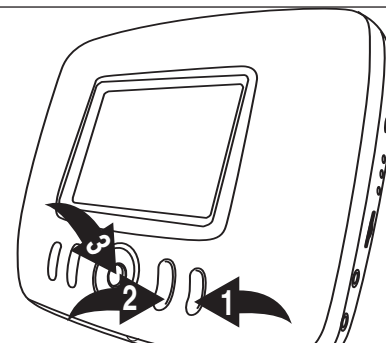

During playback, press either the Search ▶▶ button ❶ or Search ◀◀ button ❷ to move the CD forward or backward at double (x2) speed to locate a specific section. Repeatedly press these buttons and the speed will increase to x4, x8, x16 and resume normal playback.

The CD will move forward or backward at high speed until the Play (▶) button ❸ is pressed; normal playback will resume at that point.

SKIP

1

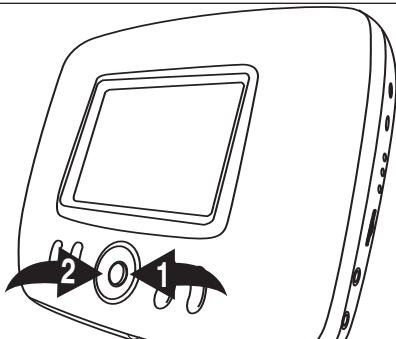

Press the Skip (▶▶) button ❶ to advance the DVD to the beginning of the next track.

Press the Skip (◀◀) button ❷ to move the DVD to the beginning of the previous track.

PICTURE CD OPERATION

PLAYBACK OF A PICTURE CD

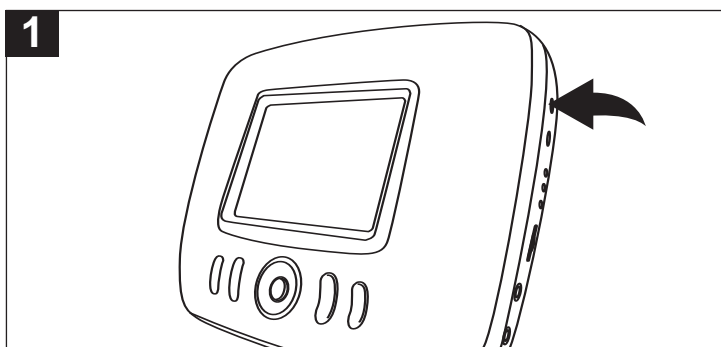

Slide the POWER switch to the ON position.

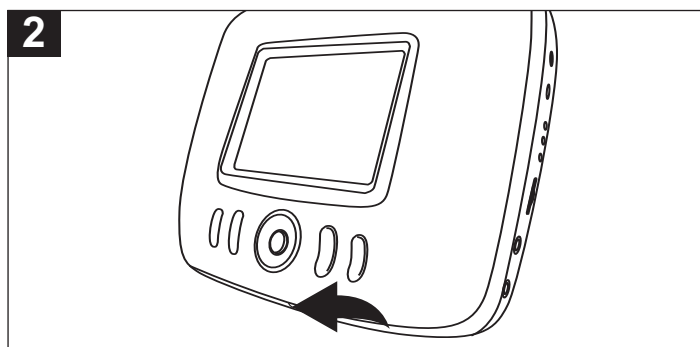

Press the Door OPEN button to open the disc tray. Insert a disc with the label side facing up on the disc tray.

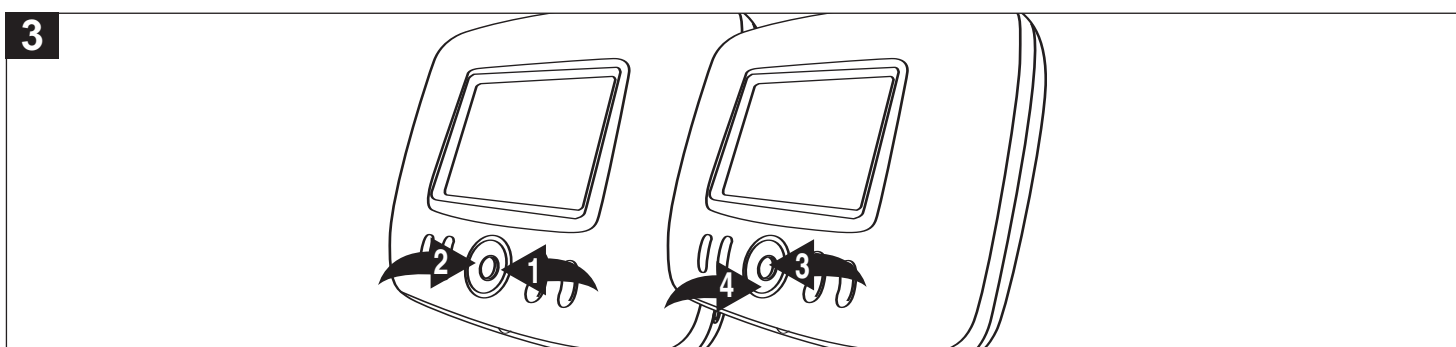

Close the disc tray. After loading, the FOLDER/TRACK menu will appear on the screen. Press the Skip ◀/Navigation left button ❶ or Skip ▶/Navigation right button ❷ to select the desired picture file, then press the ENTER button ❸ to confirm. The selected picture will appear on the screen, and then show the remaining pictures in the form of slide show. (NOTE: If there is sub-folders inside the picture CD, use the Skip ◀/Navigation left button ❶ or Skip ▶/Navigation right button ❷ to select the folder then press the ENTER button ❸ to enter the sub-folder. To return to the previous folder's menu, use the Skip ◀/Navigation left button ❶ or Skip ▶/Navigation right button ❷ to select ".." then press the ENTER button ❸ to return to the previous folder's menu.) Press the Stop (■) button ❹ to stop the Playback of the pictures and return to the Folder menu.

TROUBLESHOOTING GUIDE

Check the following before requesting service:

SYMPTOM	POSSIBLE CAUSE	POSSIBLE SOLUTION
GENERAL		
No power.	Battery weak.	Recharge the battery packs using the supplied AC adapter.
Battery has been charged but the unit still cannot be turned on.	Battery needs to be replaced.	Contact customer service at the number listed on the back cover.
Power on, but unit not functioning properly.	Condensation has formed.	Turn the unit off, unplug the power cord and wait about one to two hours to allow the player to dry.
	Wrong type of CD inserted.	This unit cannot play discs, other than DVD, MP3, picture or standard CDs.
	Unit needs to be reset.	Turn the unit off and then unplug the AC adapter. Wait one minute and then plug the unit back in.
	The disc is dirty or inserted incorrectly.	Clean disc and insert label side-up.
	Some features and functions are not available on all discs.	This is normal; try another function.
The playback picture is poor.	The disc is dirty.	Clean the disc.
The Search feature is not working.	Some discs have sections that do not allow searching.	This is normal on some discs.
The unit does not start playback.	Rating level set to block the DVD.	Enter your password, and/or change the rating level.
	DVD not inserted, or inserted upside-down. A non-playback disc is inserted.	Insert DVD correctly. Make sure to insert a DVD.
	The disc is dirty.	Clean the disc.
Some functions do not operate as stated.	Some features and functions are not available on all discs.	This is normal; try another function.
Selected language is not being shown in the subtitles, or spoken.	If the audio or subtitle language does not appear on the disc, then the initial setting will not be seen/heard.	This is normal; try another disc.
Subtitles are not working properly.	Subtitles appear only when the discs contain them.	This is normal; try another disc.
	Subtitles not turned on.	Turn the subtitles on.
The Rating Level password has been forgotten.	Password forgotten.	The default password is "1234". If you changed and forgot it, contact customer service at the number listed on the back cover of this manual.

CARE AND MAINTENANCE

Caring for Discs

- Treat the disc carefully. Handle the disc only by its edges. Never allow your fingers to come in contact with the shiny, unprinted side of the disc.

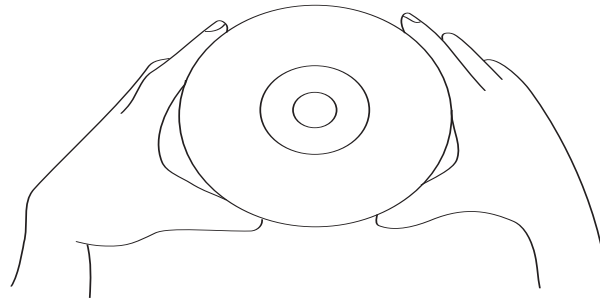

- Do not attach adhesive tape, stickers, etc. to the disc label.
- Clean the disc periodically with a soft, lint-free, dry cloth. Never use detergents or abrasive cleaners to clean the disc. If necessary, use a CD cleaning kit.
- If a disc skips or gets stuck on a section of the disc, it is probably dirty or damaged (scratched).
- When cleaning the disc, wipe in straight lines from the center of the disc to the outer edge of the disc. Never wipe in circular motions.

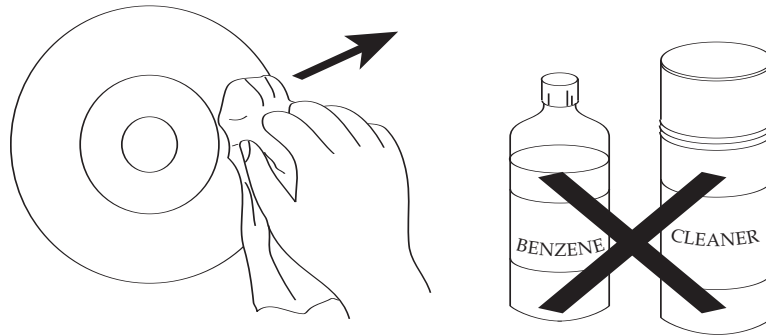

- Discs should be stored in their cases after each use to avoid damage.
- Do not expose discs to direct sunlight, high humidity, high temperatures or dust, etc. Prolonged exposure or extreme temperatures can warp the disc.
- Do not stick or write anything on either side of the disc. Sharp writing instruments, or the ink, may damage the surface.

Cleaning the Unit

- To prevent fire or shock hazard, disconnect your unit from the AC power source when cleaning.
- The finish on your unit may be cleaned with a dust cloth and cared for as other furniture. Use caution when cleaning and wiping the plastic parts.
- Mild soap and a damp cloth may be used on the front panel.

SPECIFICATIONS

Power Requirements	DC IN 9V (Center Positive)
battery packs	Ni-MH DC 3.6V x 2
Power Consumption.....	12W
Weight.....	1.5 LB (main unit + battery packs)
Dimensions	6.6 (W) x 5.4 (H) x 2.4 (D) inches
Weight and dimensions are approximate.	
Operating Temperature.....	+5° to +35°C
Operating Humidity Range	5% to 90% (no condensation)

Discs Played:

DVD-VIDEO Disc

- 12cm single-sided, single layer
- 12cm single-sided, dual layer
- 12cm double-sided, single layer
- 8cm single-sided, single layer
- 8cm single-sided, dual layer
- 8cm double-sided, single layer

COMPACT DISC

- 12cm disc
- 8cm disc

Audio Signal Output Characteristics:

Frequency Responses:

DVD (Linear Audio).....	125Hz to 18KHz
CD Audio.....	125Hz to 18KHz
S/N Ratio	70dB
Wow and Flutter.....	Below Measurable Level

Pickup:

Wavelength	655nm
Laser Power.....	Class 1

Specifications are subject to change without notice.

For additional set-up or operating assistance, please visit our website at www.disneyelectronics.com or contact customer service at (954) 660-7026.

Please keep all packaging material for at least 90 days in case you need to return this product to your place of purchase or Memcorp.

For parts and accessories, contact Fox International at 1-800-321-6993.

Distributed by Memcorp Inc., Weston, FL, Disney Elements © Disney 2005.

Para informacion adicional sobre la configuracion o si necesita asistencia con la operacion del equipo, por favor visitenos en nuestra pagina web www.disneyelectronics.com o si requiere asistencia directa, comuniquese con nuestro departamento de servicio al cliente al numero (954) 660-7026.

Por favor mantenga todo el material de empaque por lo menos por 90 dias, en caso que usted necesite devolver el producto donde lo compro a directamente a Memcorp Inc.

Para Accesorios o Partes en general, por favor comuniquese con Fox International al numero 1-800-321-6993.

Distribuido por Memcorp Inc. Weston, FL, Disney Elements ©Disney 2005.

Pour obtenir des informations supplémentaires sur l'installation ou une assistance concernant l'emploi de votre produit, veuillez visiter notre site Web sur www.disneyelectronics.com ou contacter notre service clientèle au (954) 660-7026.

Veillez conserver tout matériel d'emballage pendant au moins 90 jours au cas où vous devriez renvoyer votre produit à votre revendeur ou directement à Memorex.

Pour les pieces et les accessoires, contactez Fox International at au 1-800-321-6993